



Alu-Bast

The Alu-Bast collection by ONE A is a modular system, which can be assembled in various constellations.

The collection consists of two main components, respectively in aluminium and alabaster, both available in different lengths.

An elegant soft light is emitted through the alabaster stone, creating a cozy atmosphere.

TUBE

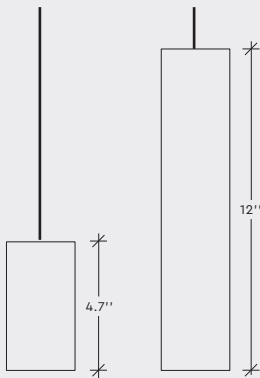

ALUBASTER

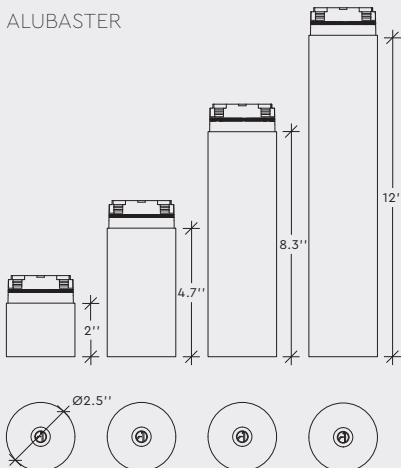

The crossed-out wheeled bin symbol indicates that the item should be disposed of separately from household waste. The item should be handed in for recycling in accordance with local environmental regulations for waste disposal. By separating a marked item from household waste, you will help reduce the volume of waste sent to incinerators or land-fill and minimize any potential negative impact on human health and the environment.

ONE A reserves the rights to change and/or update product information and accepts no liability for any printing errors.
last updated 29 - 11 - 2021

ALU-BAST CC - PENDANT

DATA

Collection	ONE A
Product	ALU-BAST
Article no.	1N13.4391.xx73 (Tube 120, Alubaster 50) 1N13.4392.xx73 (Tube 120, Alubaster 120) 1N13.4393.xx73 (Tube 120, Alubaster 210) 1N13.4394.xx73 (Tube 120, Alubaster 300) 1N13.4491.xx73 (Tube 300, Alubaster 50) 1N13.4492.xx73 (Tube 300, Alubaster 120) 1N13.4493.xx73 (Tube 300, Alubaster 210) 1N13.4494.xx73 (Tube 300, Alubaster 300)

SPECIFICATIONS

Weight	1.72lb - 5.29lb
Material	Aluminium, Alabaster
IP protection grade	IP20
Insulation class	Class III
Supply	Constant Current 5W 34V 130mA (light source included)
CCT	2700k (nature stone - variations can occur!)
Lumen	130-250lm
Efficiency	30-45lm/W
CRI	90+
IES/LDT	For IES/LDT lux files review STORM SYSTEM® - LUX FILES ➤
Labelling	ETL PENDING

Energy Classifications



DRIVER

This product shall always be powered by SELV LED driver, output voltage of this driver in open circuit must not exceed 60V.

For further support contact LITES ON WEST
245 West 29th Street, 6th floor | NY, NY 10001
T: 212 775 6363 | F: 212 775 0355
E: info@litesonwest.com

XX - COLOUR CODES

01 - White	97 - Gold
53 - Elephant Grey <i>cross-brushed</i>	98 - Silver
92 - Black Pearl	99 - Bronze

NOTE

9.84 ft cord included.

Due to pendant weight, some AluBast pendants are delivered including a metal wire. The metal wire can be fixed to Storm Output - see technical info for more information

IMPORTANT INFORMATION

Installation and mounting must be performed by a certified electrician only, and instructions must be followed.

CLEANING AND MAINTENANCE:

Use a soft moist cloth for cleaning. No further maintenance is required.

WARRANTY:

If the product is defect, please contact your supplier immediately. Please note that warranty will not apply in case of wrongful use or if unskilled personnel attempts to repair.

COMPONENTS

- AluBast
- wire
- light source
- allen key

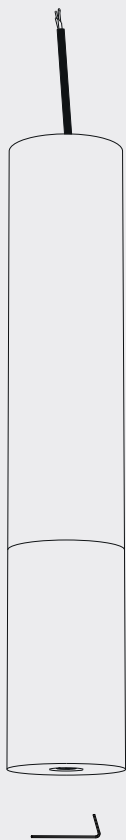

ALU-BAST PENDANT

ASSEMBLY INSTRUCTION page 1 of 2

STEP 1

Make sure main power is off!

Connect the cables

BE ATTENTIVE! Make sure you have connected the power correctly, please refer to Storm Output assembly instructions or other outlet

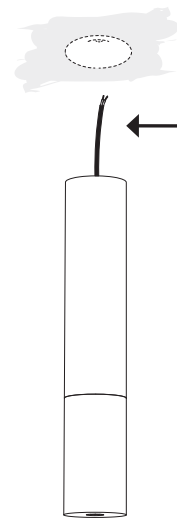
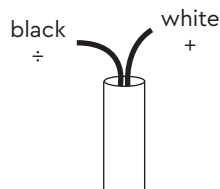

INSTRUCTIONS TO CHANGE LIGHT SOURCE

STEP 1

Make sure main power is off!

To remove Alabaster Part:

1. With the accompanying allen key turn the screw clockwise until the Alabaster part can rotate
2. Take hold of the Alabaster part, then gently pull down, whilst slightly rotating

NOTE: When rotating the fixture choose the direction with the least resistance.

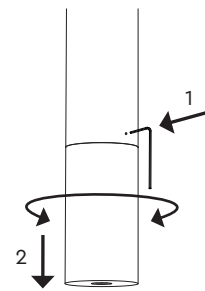

STEP 2

1. Turn the 3 screws anti-clockwise using the allen key.
2. Remove the retaining ring using light pressure.

Then replace the light source, reattach the retaining ring, make sure it snaps. Finally, fasten the 3 screws, so that they are flush with the fixture ring.

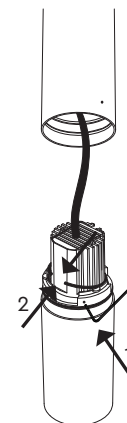

STEP 3

1. Remount the Alabaster part in the Tube, by gently rotating until the allen screw aligns with the hole in the Tube.
2. Secure the Alabaster part in place by turning the screw anti-clockwise until the screw is flush with the tube.

NOTE: When rotating the fixture choose the direction with the least resistance.

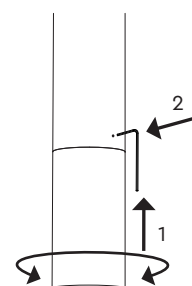

ALU-BAST PENDANT

ASSEMBLY INSTRUCTION page 2 of 2

Suspension wire can be mounted in Storm Output, for further information refer to Storm Output's technical information.

Feed the accompanying steel wire through the small hole in Storm Output, then fasten the screw

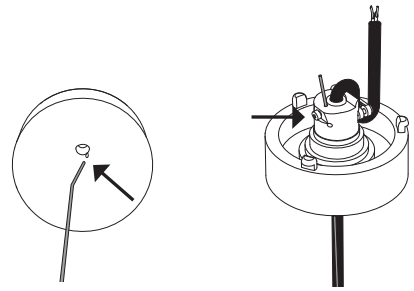

WIRE SUSPENSION ASSEMBLY INSTRUCTION

STEP 1

Mount the wire suspension to the ceiling with a screw.

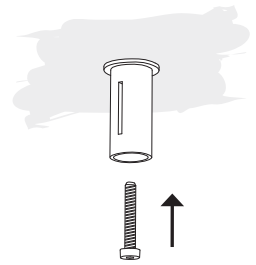

STEP 2

Mount the wire lock in the wire suspension.

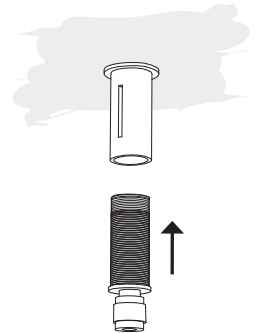

STEP 3

Guide the wire through the wire lock

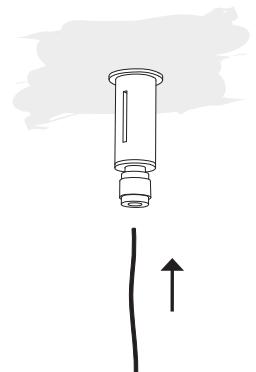

STEP 4

Then pull the wire out through the slot

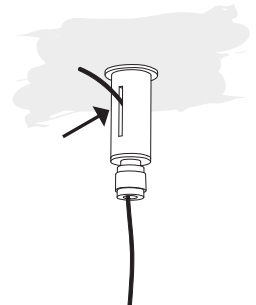

IMPORTANT INFORMATION

Disassembly must be performed by a certified electrician only, and instructions must be followed.

WARRANTY:

If the product is defect, please contact your supplier immediately. Please note that warranty will not apply in case of wrongful use or if unskilled personnel attempts to repair.

ALU-BAST PENDANT

DISASSEMBLY INSTRUCTION

STEP 1

Make sure main power is off!
Disconnect the cables

Please refer to Storm Output assembly instructions or other outlet

